



Nikon ^(th)
100
anniversary

A1+

Confocal Microscope



The ultimate confocal microscope

A1⁺ A1R⁺

Smart Tools for Superior Results

Nikon's modular A1⁺/A1R⁺ confocal laser scanning microscope system can meet the most demanding imaging requirements with hardware and capabilities that are continuously updated to achieve both high-quality images for spatial information and high speed images of fast-moving events.

Optimized sensitivity

It starts with Nikon's optical design and quality, coupled with intelligent electrical design to maximize signal throughput, mechanical improvements to gather more emitted photons, and improved detectors for high sensitivity, even at extremely high speed acquisition.

Maximizing resolution

The high resolution galvanometer scanner (A1⁺/A1R⁺), and the high frequency resonant scanner (A1R⁺), together with Nikon's unique image correction technologies, ensure the highest spatial and temporal resolutions. The high definition resonant scanner provides imaging of 1024 x 1024 pixels (15 fps).

Designed for high speed imaging

Imaging beyond the normal video rate (up to 420 fps) means capturing fast moving events while simultaneously illuminating for a shorter time, maintaining more live-sample friendly imaging.

Spectral sensitivity

A variety of spectral detection options allow simultaneous acquisition of 32 channels of emission, or user-defined emission bandwidths. High-sensitivity detector options allow tunable emission spectral imaging with resonant scanning.



Selectable scan head enables high-speed, high-quality imaging

The A1R+ is a hybrid scan head that incorporates both a high-resolution galvano (non-resonant) scanner and an ultrahigh-speed resonant scanner. Hybrid scan heads allow imaging and photoactivation at the ultrafast speeds necessary for revealing cell dynamics and interaction. The A1R+ is equipped with a galvano scanner for high-resolution imaging.

A1R+ hybrid scan head

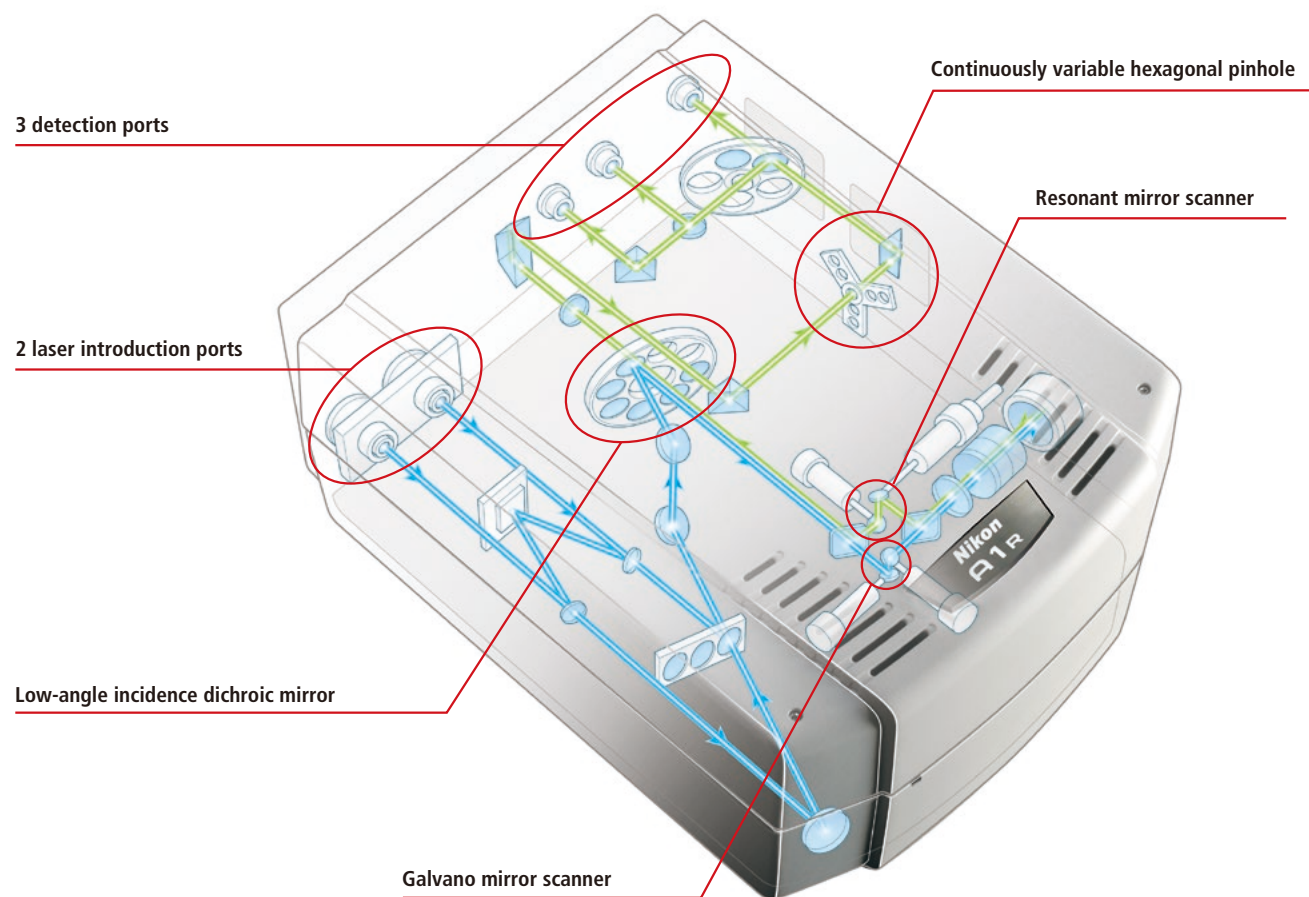

Continuously variable hexagonal pinhole

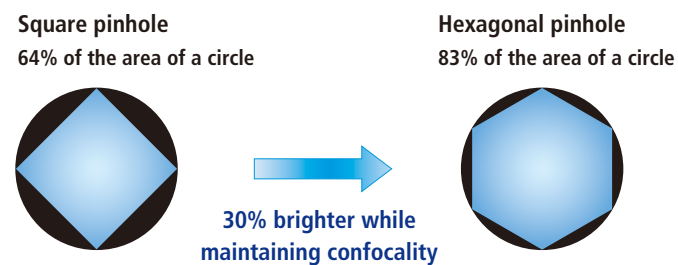

Low-angle incidence dichroic mirror

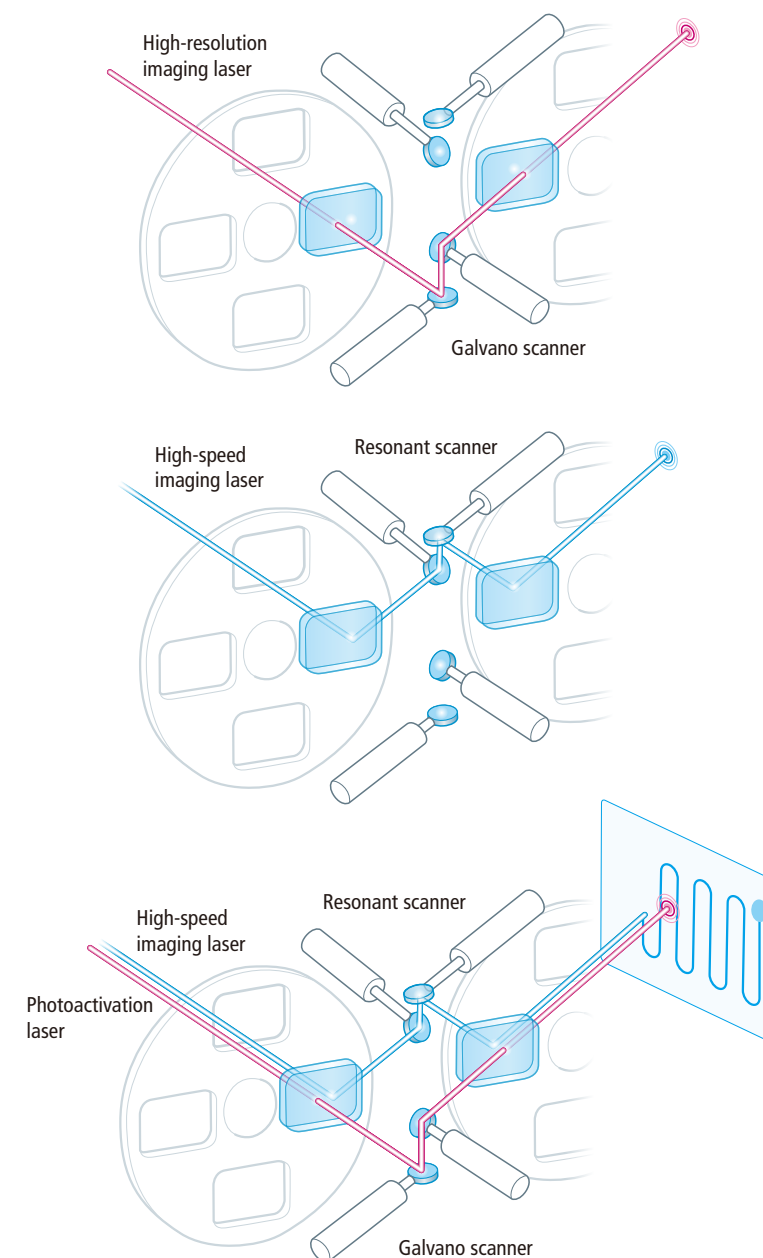
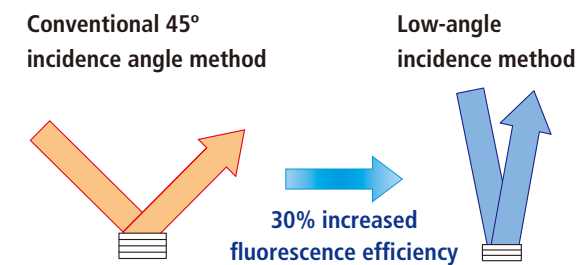

High resolution imaging with A1+ and A1R+

Both A1+ and A1R+ are equipped with a galvano scanner enabling high resolution imaging of up to 4096 x 4096 pixels. This scanner can capture images at up to 10 fps (512 x 512 pixels).

Ultrafast imaging with A1R+

The A1R+ scan head is equipped with a resonant scanner enabling frame rates of up to 420 fps (512 x 32 pixels), or resolutions of up to 1024 x 1024 pixels (15 fps).

Hybrid scanning

Imaging and photostimulation can be carried out simultaneously by utilizing both resonant and galvano scanners in the A1R+.

	Galvano	Resonant
1D scanning	5,200 lps (lines per second)	15,600 lps
2D scanning	130 fps (512 x 32 pixels)	420 fps (512 x 32 pixels)
Full frame scanning	10 fps (512 x 512 pixels)	60 fps (256 x 256 pixels), 30 fps (512 x 512 pixels), 15 fps (1024 x 1024 pixels)



Ultimate high resolution 1K resonant scanner

Nikon's new resonant scanner mounted in the A1R+ scan head supports both high speed and high resolution imaging. The wide dynamic range and reduced noise level raises the bar for image quality in resonant scanners.

High resolution

A new resonant scanner achieves finely detailed images with a maximum resolution of 1024 x 1024 pixels (15 fps). A newly developed sampling method produces sharper images with any configuration: even at lower resolution settings. When combined with Nikon's high NA objective lenses, the A1R+ can achieve absolute optical precision.

Large field of view

With both 1024 x 1024 pixel resolution and a large field of view (FOV18), the new resonant scanner delivers higher throughput in various imaging applications.

High speed

The fast acquisition speed of the resonant scanner is able to capture images with a very short dwell time, minimizing excitation time and light energy exposure of the samples.

Multicolor

Up to 5 channel (four-channel episcopic detector plus diascope detector) simultaneous imaging is possible.

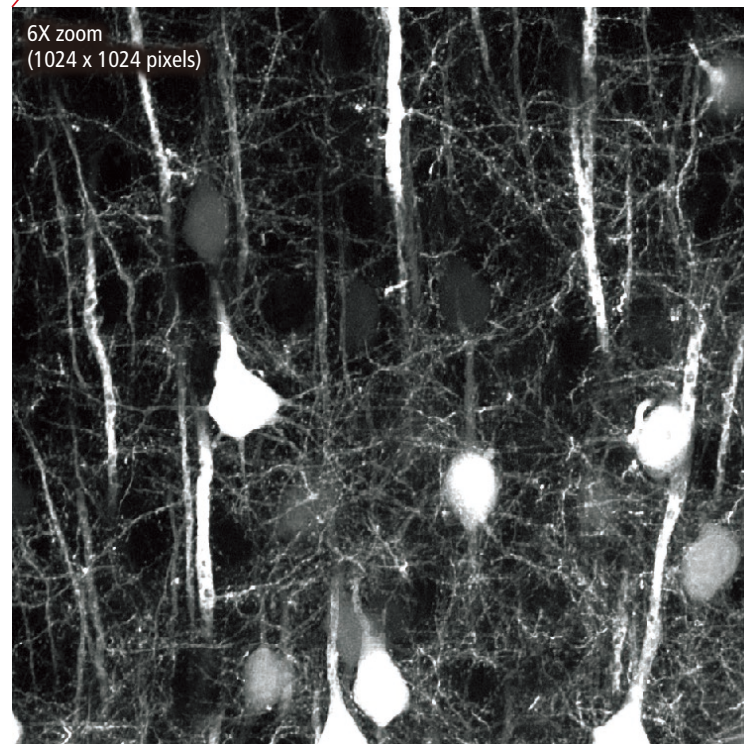
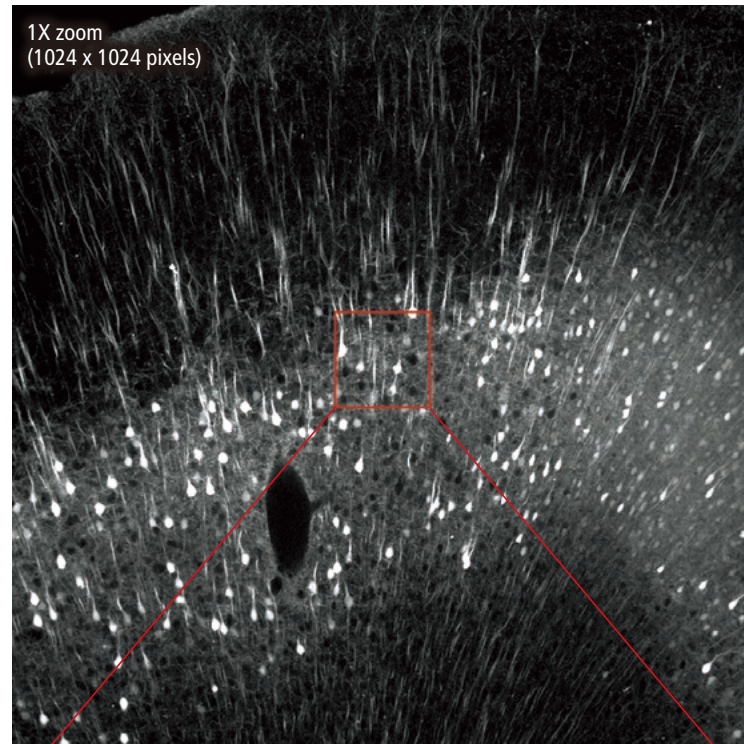

Comparison of a large FOV image and detailed image of fine structures in a cleared* 2 mm brain slice of H-line mouse. Photographed with the cooperation of: Drs. Ryosuke Kawakami, Kohei Otomo, and Tomoni Nemoto, Research Institute for Electronic Science, Hokkaido University
*RapiClear1.52, SunJin Lab

A continuum of imaging solutions

Nikon confocal microscopes are engineered with a range of new technologies, features and performance enhancements that are always kept up to date for superior results. Nikon's performance and versatility enables you to bring your imaging aspirations to life.

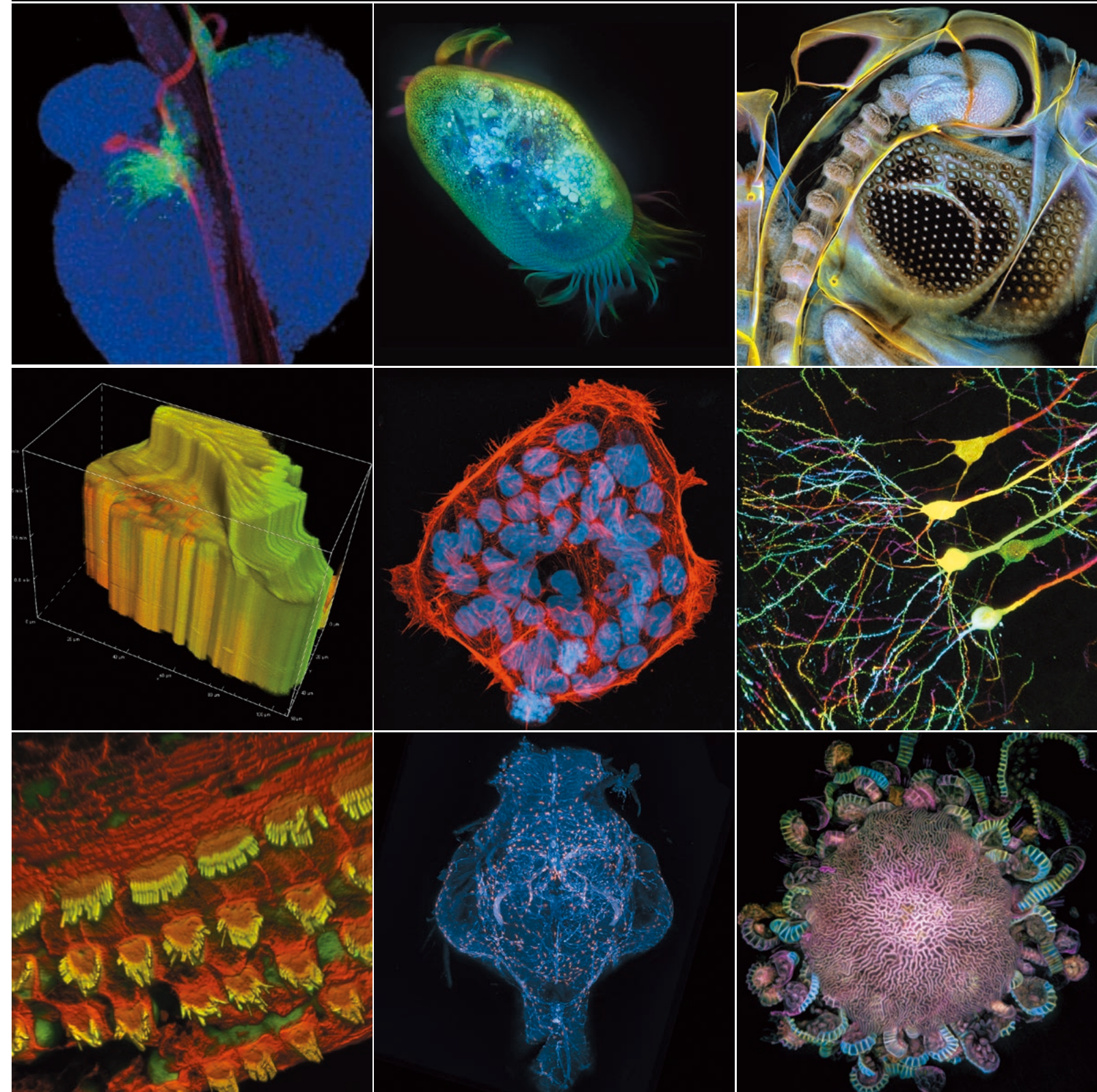

High resolution multi-dimensional imaging

The high resolution galvano scanner enables acquisition of images of up to 4096 x 4096 pixels in up to 5 channels (four-channel fluorescence plus diasopic DIC) by using the A1-DU4-2/DUG-2 or A1-DUVB-2 detector.

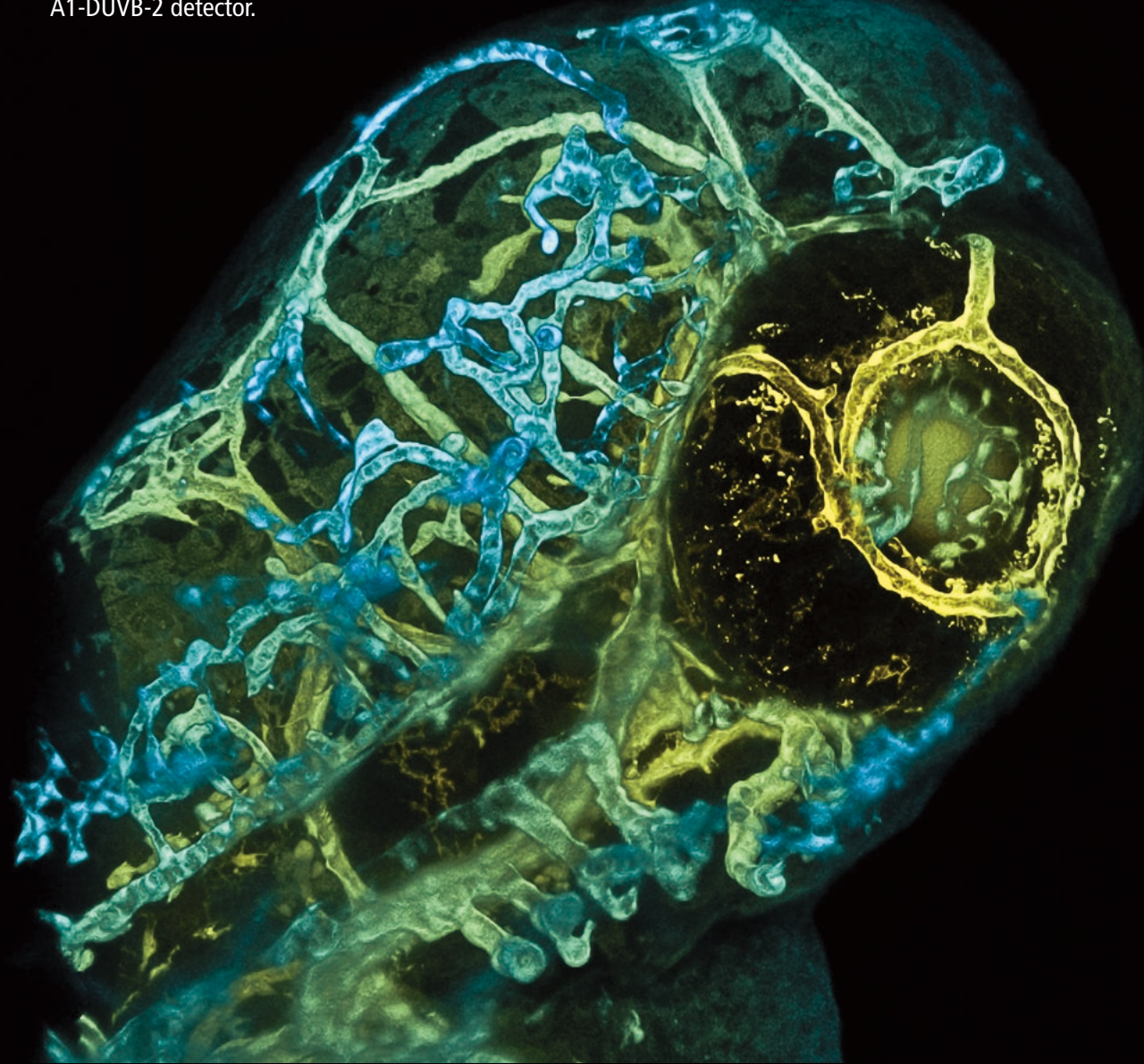

Fast volumetric time-lapse imaging

Resonant scanning coupled with fast piezoelectric Z drivers allows capture of fast 4D volumes. Multiple Z stacks can be acquired each second, allowing the acquisition of not just 2D, but rapid succession 3D datasets versus time.

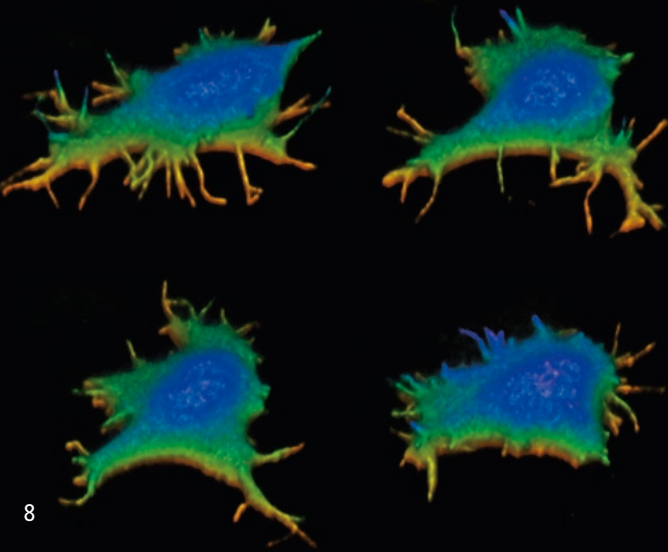

High speed imaging with resonant scanners

Ultra-fast scanning with the resonant scanner allows low excitation dosages and captures fast physiological processes. The Nikon original optical pixel clock generation method realizes high image quality even at the highest speeds.

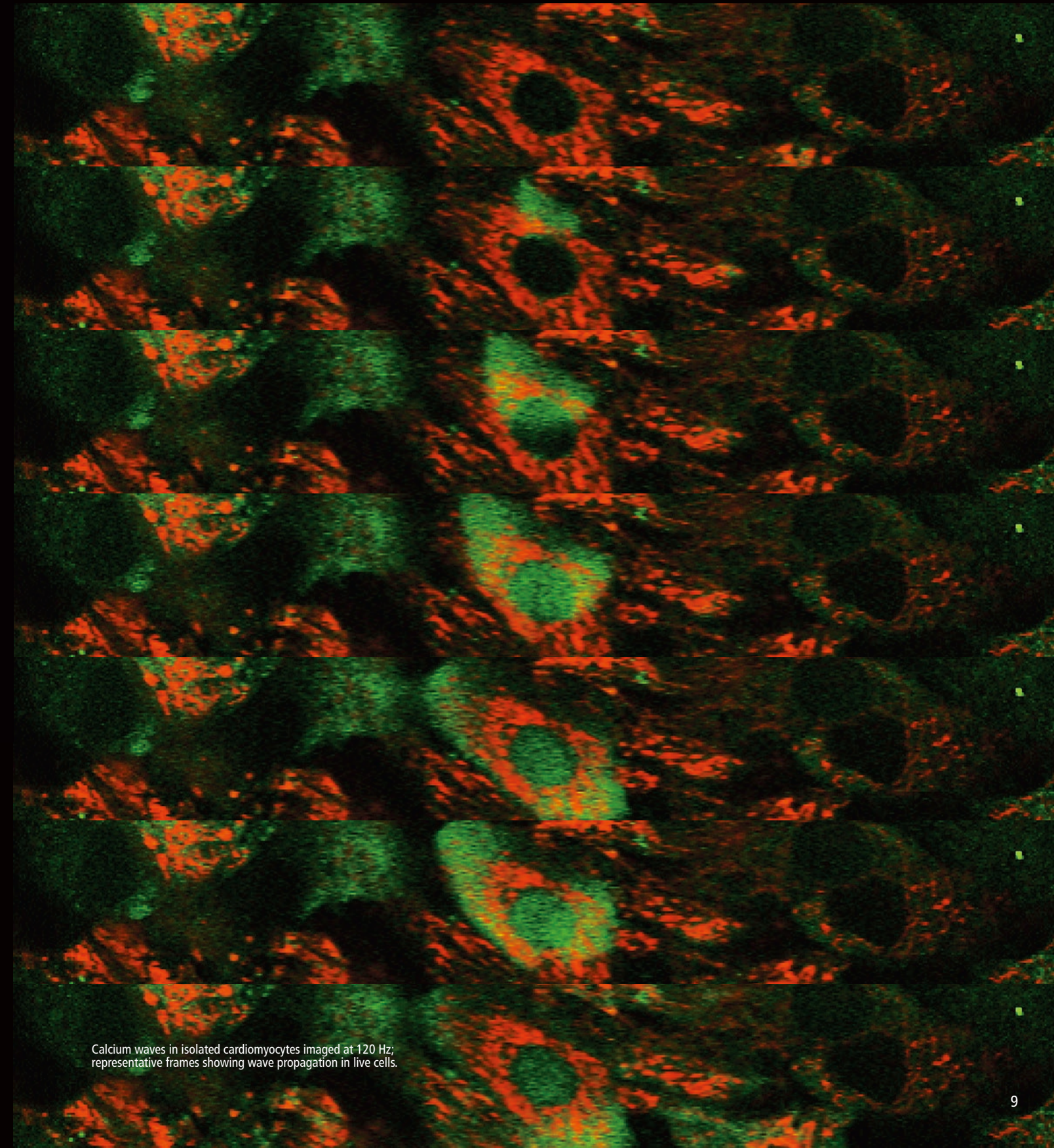

Calcium waves in isolated cardiomyocytes imaged at 120 Hz; representative frames showing wave propagation in live cells.

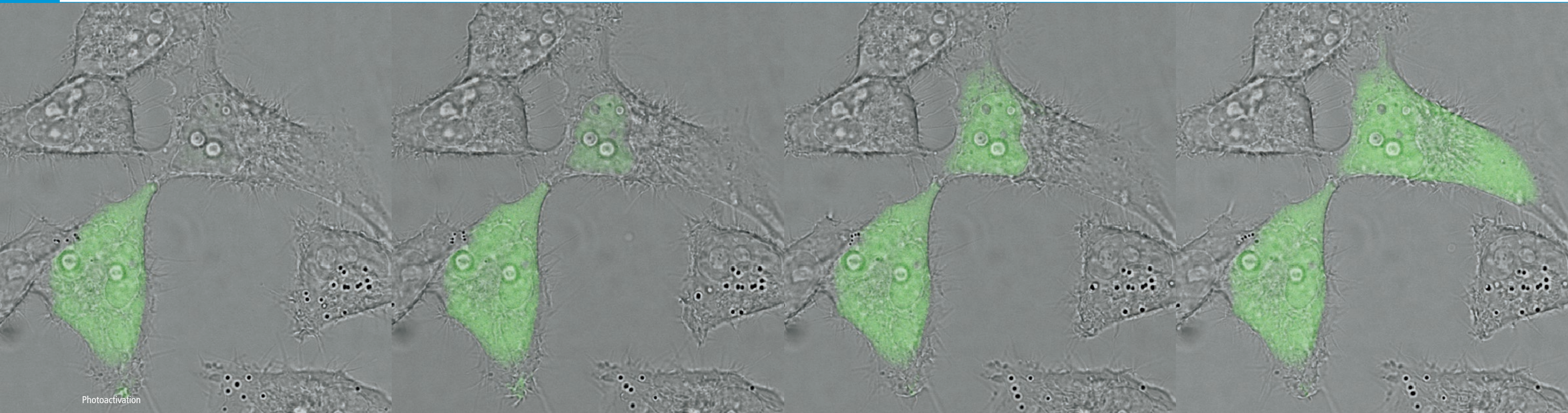

The unique hybrid scanning layout of the A1R+ allows simultaneous imaging and photostimulation. This enables instantaneous imaging of the results of or recovery from photostimulation. NIS-Elements C imaging software performs all types of photostimulation experiments in guided workflows, including photoactivation, photoconversion, FRAP, FLIP, and caged-compounds.

In the A1R+ system, the resonant scanner acquires images while the galvano scanner is used to direct the photostimulation laser. Imaging with the resonant scanner ensures the fastest acquisition possible.

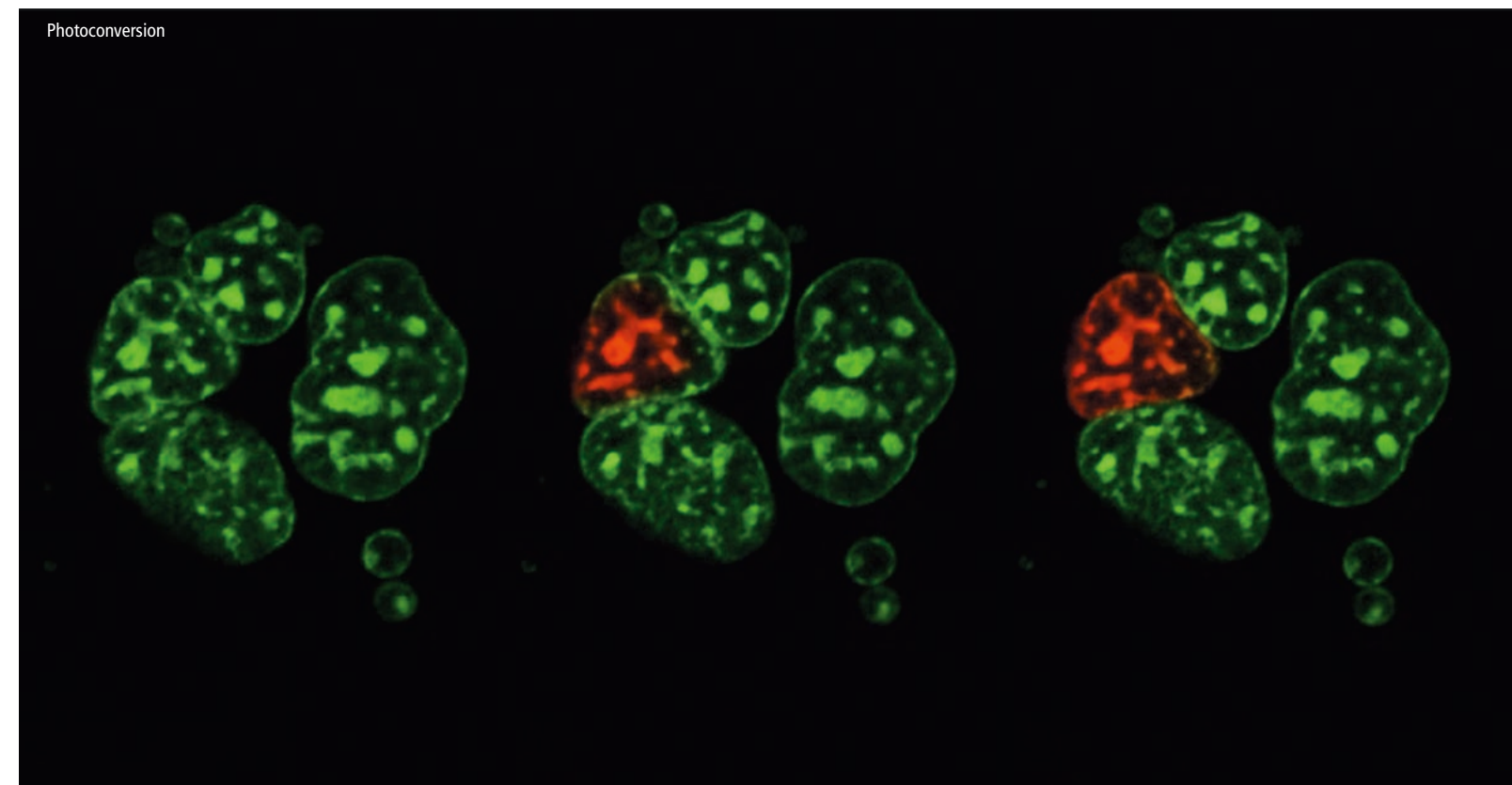
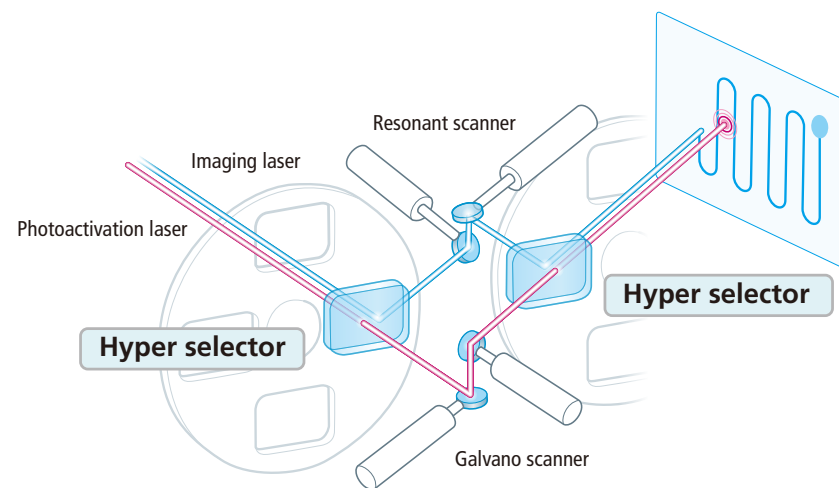

High-sensitivity GaAsP detectors

Implementation of high-sensitivity gallium arsenide phosphide (GaAsP) detectors have created a new standard in image quality. GaAsP PMT cathodes achieve much higher quantum efficiency than conventional detectors, resulting in brighter imaging with minimal noise, even while imaging at high speed. The combination of low light dosage, high sensitivity, and rapid imaging makes resonant scanning a very effective tool for acquisition of living specimens or to increase speed and efficiency in high-throughput workflows.

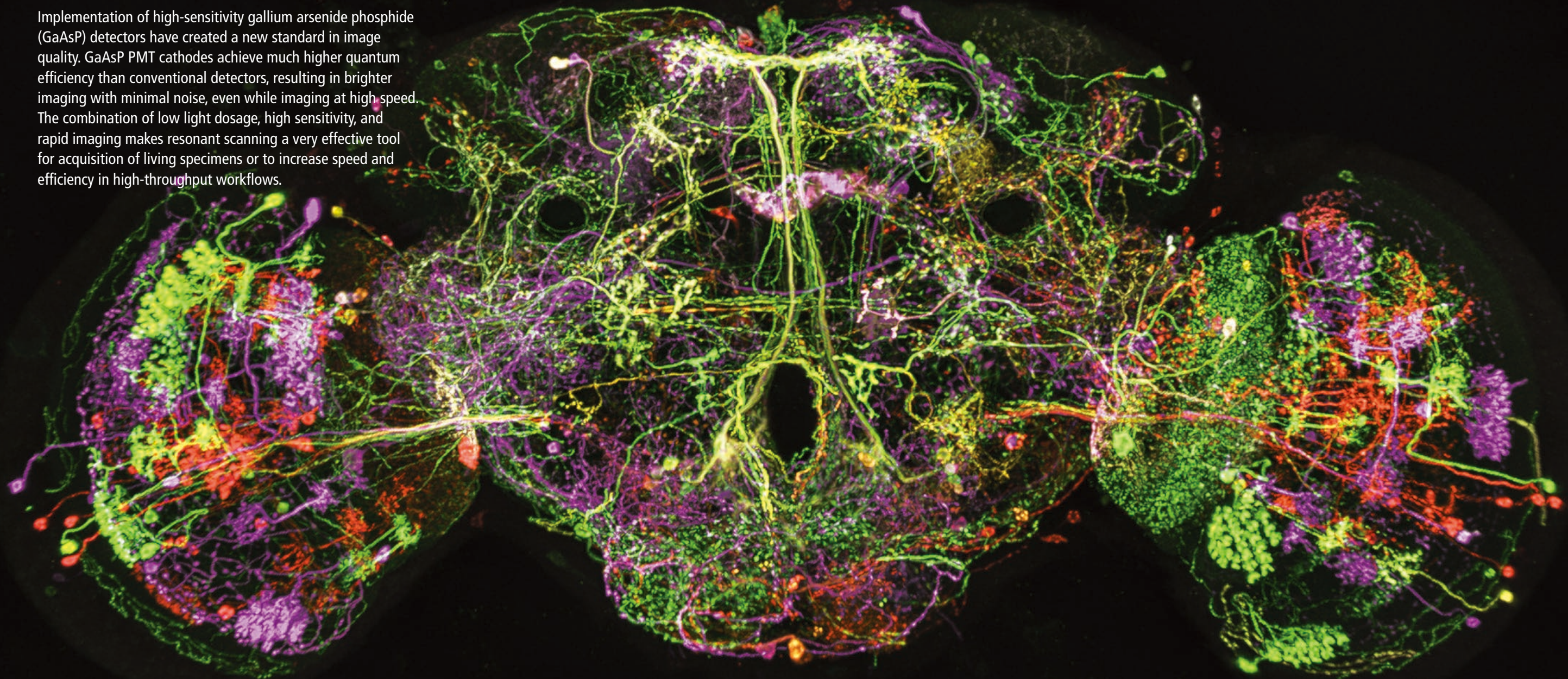

Hybrid GaAsP detector

A1-DUG-2 is a 4-channel detector utilizing both GaAsP and Multi-Alkali PMTs, assigning the detector based on sensitivity at the emission wavelength of fluorescence for the maximum sensitivity.



DUVB GaAsP detector

A1-DUVB-2 is a tunable bandwidth emission GaAsP detector unit that allows custom-defined emission bandwidths for imaging in up to 5 channels.



Sensitivity comparison of GaAsP PMT and Multi-Alkali PMT

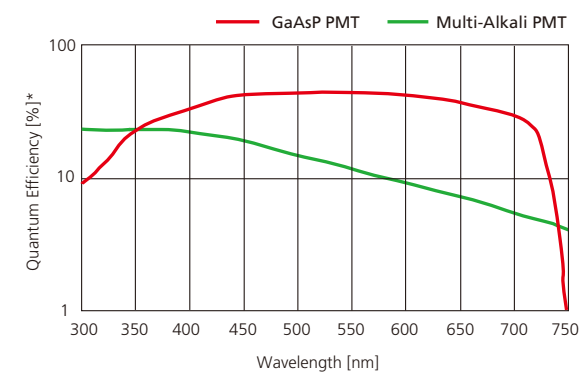

GaAsP PMT realizes higher sensitivity than Multi-Alkali PMT, thus offering high quantum efficiency up to 45%.
* Quantum efficiency indicates logarithm

Enhanced spectral detectors

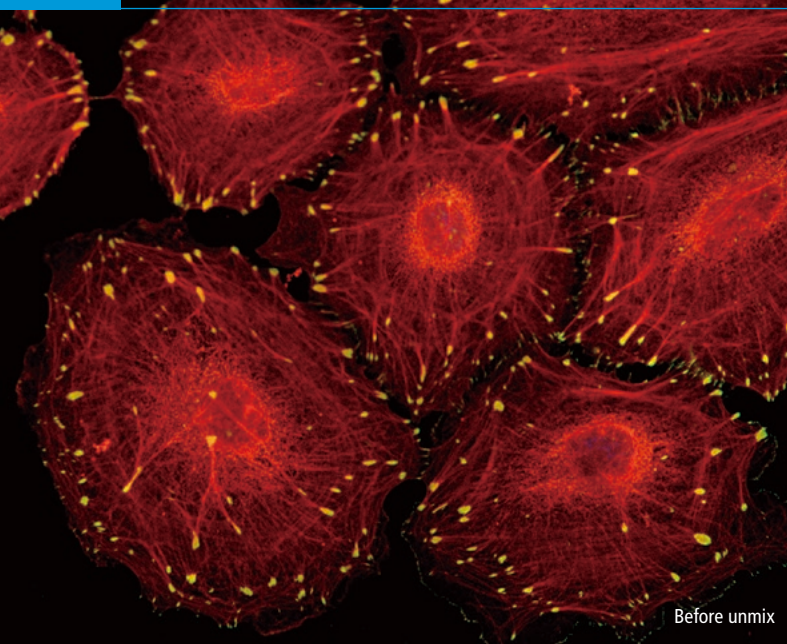

Before unmix

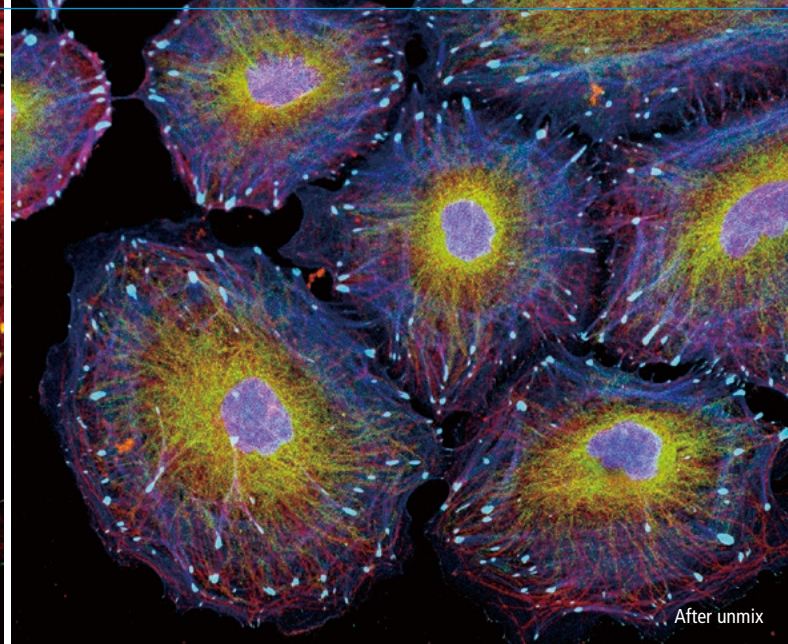

After unmix

Spectral and unmixed images of five-color-fluorescence-labeled HeLa cells
Specimen courtesy of: Dr. Tadashi Karashima, Department of Dermatology, Kurume University School of Medicine

A1-DUS spectral detector unit

Fast 32-channel imaging at 24 fps

Spectral imaging over a 320 nm wavelength range is possible with a single scan. Acquisition of 512 x 512 pixels in 0.6 second and 512 x 32 pixels at 24 fps can be achieved.

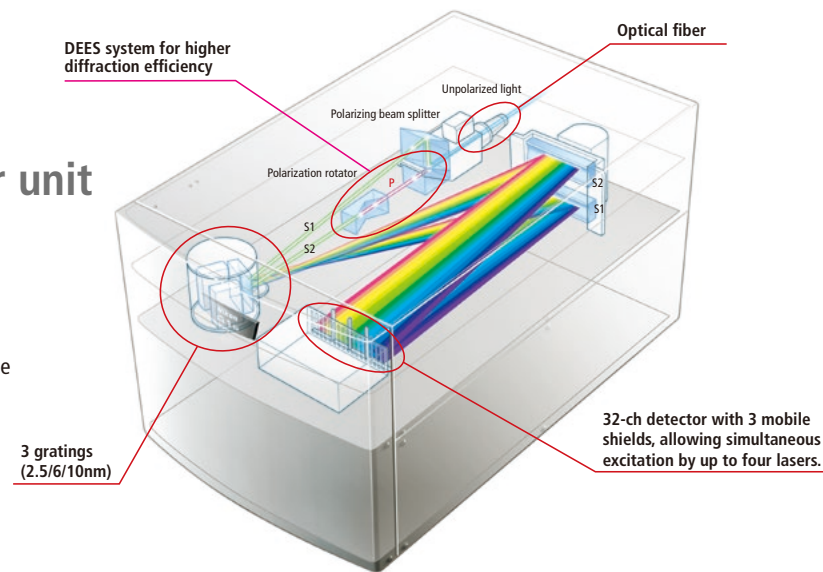

Accurate spectral unmixing

High wavelength resolution of at least 2.5 nm enables accurate separation of closely overlapping fluorescence spectra and the elimination of autofluorescence. In addition, probes with adjacent spectra such as GFP and YFP can be unmixed in real time during image acquisition. This is convenient for FRET analysis.

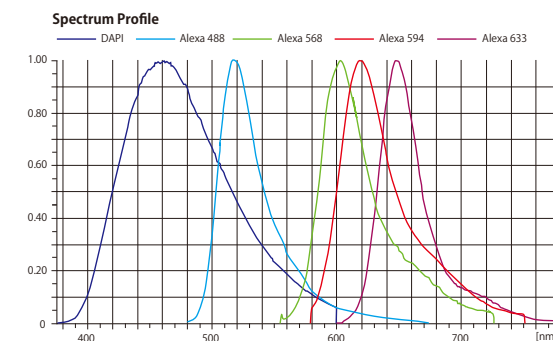

Wide band spectral imaging

Simultaneous excitation with four lasers, selected from a maximum of eight lasers of different wavelengths, is possible.

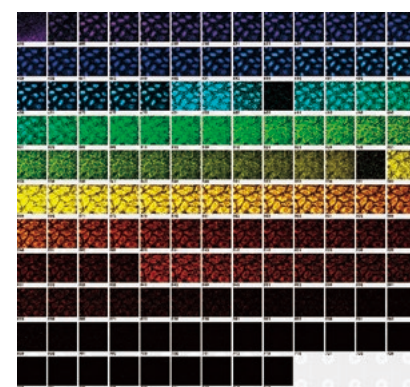

The λ scanning function of ND acquisition software allows image capturing of a wide wavelength range of up to 350 nm (140 channels) with a high wavelength resolution of 2.5 nm.

Filter-less intensity adjustment is possible with V-filtering function

Up to four desired spectral ranges can be selected from 32 channels and combined to perform a filtering function that matches the spectrum of the fluorescence probe being used. By specifying the most appropriate wavelength range, image acquisition is possible at the optimal intensity of each probe in FRET and co-localization. The sensitivity of each range can be individually adjusted.

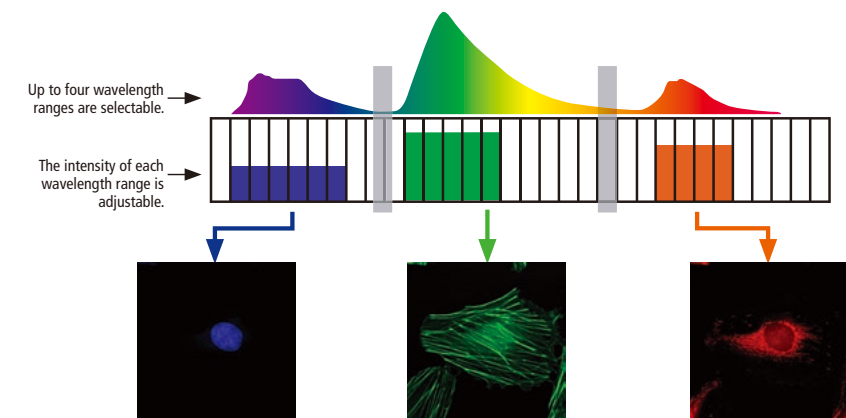

A1-DUVB-2 GaAsP detector unit

High-sensitivity spectral image acquisition

With a GaAsP PMT, the A1-DUVB-2 tunable emission detector delivers flexible detection of fluorescent signals with higher sensitivity.

Variable acquisition wavelength range

The A1-DUVB-2 is a compact fully tunable emission detector unit capable of spectral imaging with user-defined emission bandwidths of as little as 10nm, in both galvano and resonant imaging modalities, eliminating the need for fixed bandwidth emission filters. Spectral images of multi-labeled specimens can be acquired by capturing a series of spectral images while changing detection wavelengths.

Optional second channel detector

An optional second GaAsP PMT allows simultaneous two-channel imaging such as FRET and ratio imaging. Users can divert selected wavelengths to the second fixed bandwidth emission channel by inserting a dichroic mirror, while simultaneously utilizing the user-definable emission band on the first channel.

HeLa cells labeled with five-color fluorescence, Nucleus: DAPI, Vimentin: Alexa Fluor® 488, Lamin: Alexa Fluor® 568, Tubulin: Alexa Fluor® 594, Actin: Alexa Fluor® 633
Specimen courtesy of: Dr. Tadashi Karashima, Department of Dermatology, Kurume University School of Medicine

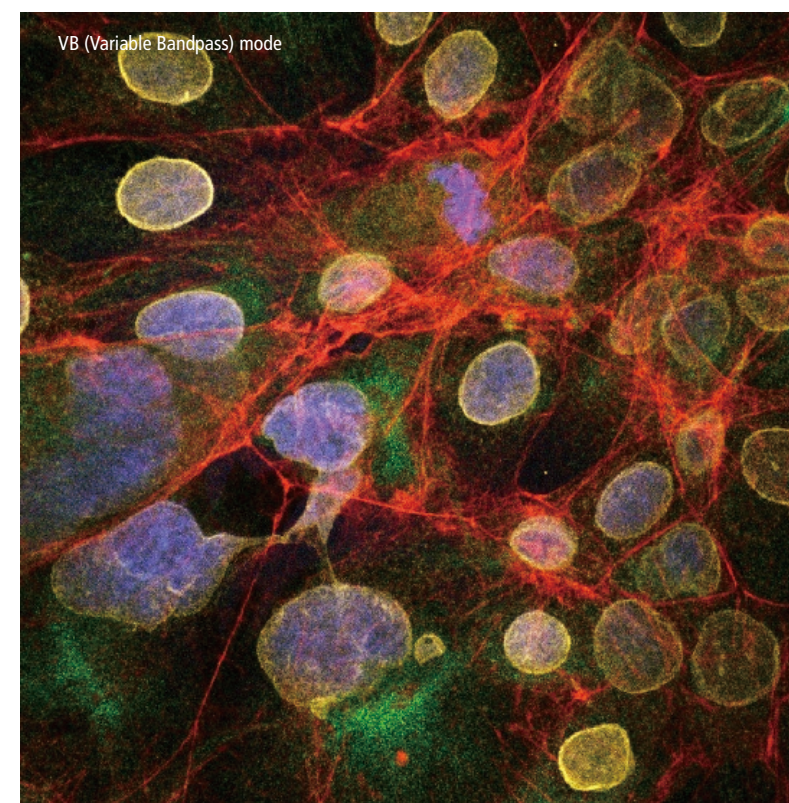

VB (Variable Bandpass) mode

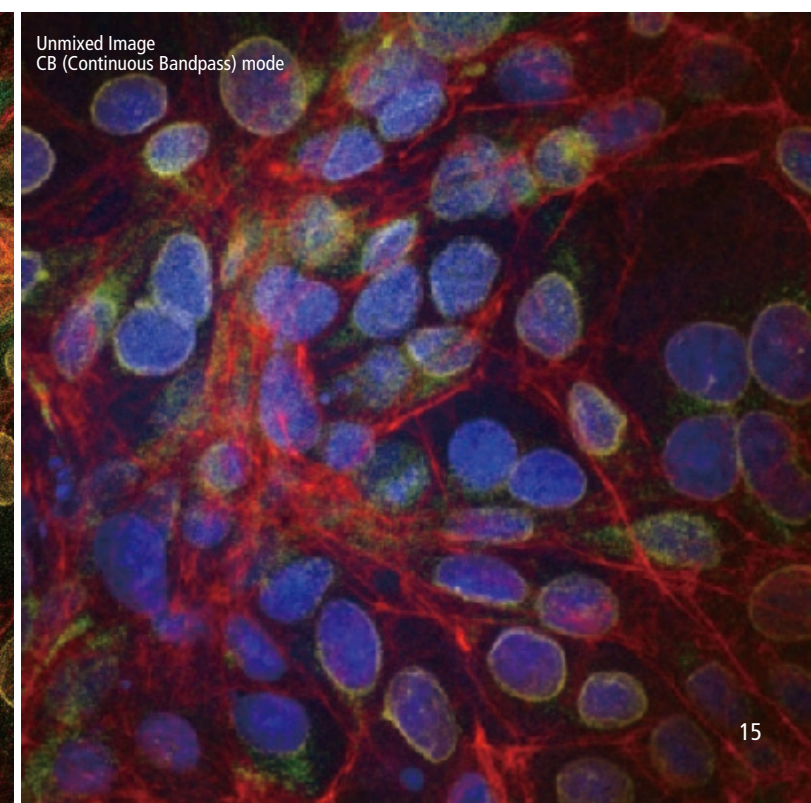

Unmixed Image
CB (Continuous Bandpass) mode

A unified acquisition and analysis software platform

NIS-Elements C, Nikon's unified software platform, provides intuitive workflow for confocal imaging. Combined with the graphical programming tools such as JOBS and illumination sequence, the comprehensive operational environment can be fully customized for any level of application needs.

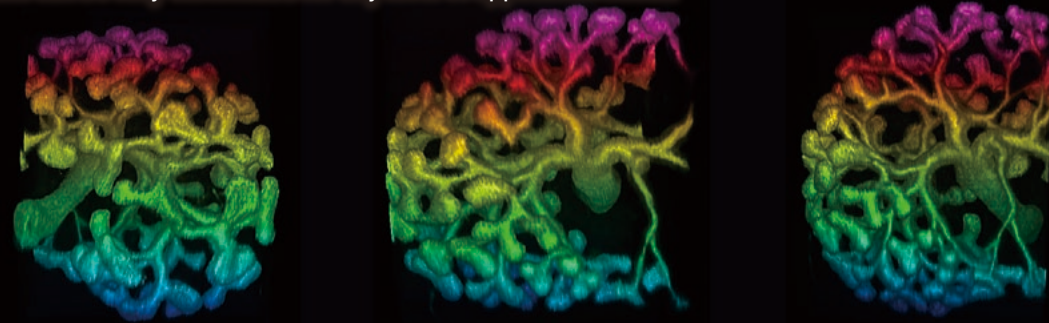

3D volume rendering of a kidney labeled with Hoxb7/myrVenus marker (Chi et al, 2009 Genesis)
Photographed with the cooperation of Drs. Frank Costantini and Liza Pon, Columbia University Medical Center, New York

NIS-Elements C

Detailed operability based on analysis of confocal microscope operation patterns provides an intuitive interface and operation. Complicated experiment sequences such as photoactivation can be carried out with easy-to-use settings.

NIS-Elements C-ER*

Higher resolution images can be generated with a single click. The software assesses the captured image and automatically determines processing parameters to achieve increased resolution. The unique image processing technology increases image resolution beyond that of a conventional confocal image (resolution can be improved 1.5 times (XY), 1.7 times (Z)).

* NIS-Elements C-ER not sold in all areas. ER functionality is available as an add-on module for NIS-Elements C in the Americas.

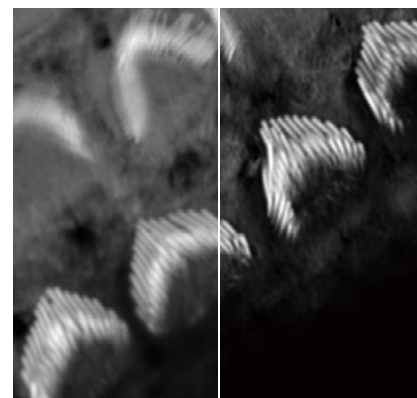

Apical surfaces of auditory epithelia of mouse cochleae were stained by Atto-565-phalloidin at postnatal day 2. Photographed with the cooperation of: Dr. Hideru Togashi, Division of Molecular and Cellular Biology, Department of Biochemistry and Molecular Biology, Kobe University Graduate School of Medicine.

Left: without C-ER, right: with C-ER

Device Control

Multidimensional Imaging

Optical configuration settings can be combined in the ND acquisition GUI to create experiments combining multichannel, multi-stage position, z-stacking, and timelapse imaging. Photostimulation and photobleaching can also be flexibly combined.

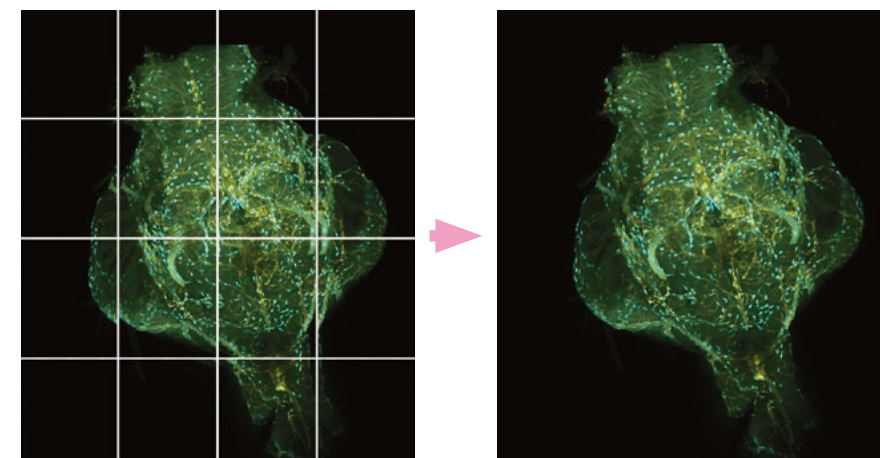
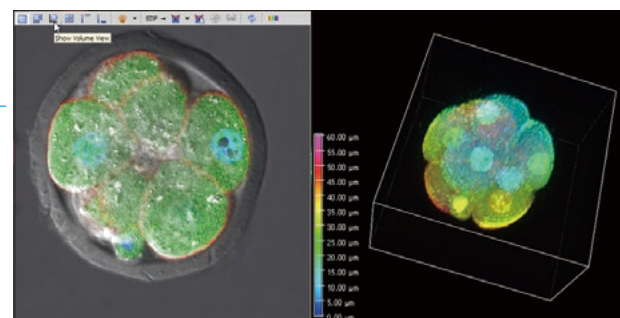

Large image (image stitching)

Images of adjacent fields that are continuously captured with the motorized stage are automatically stitched to produce a whole high-resolution image of the tissue.

Display & Processing

Denoising

Efficient tools for removing noise or graininess from images, improving image quality in low light imaging. This greatly improves the output quality of the image for analysis and presentation.

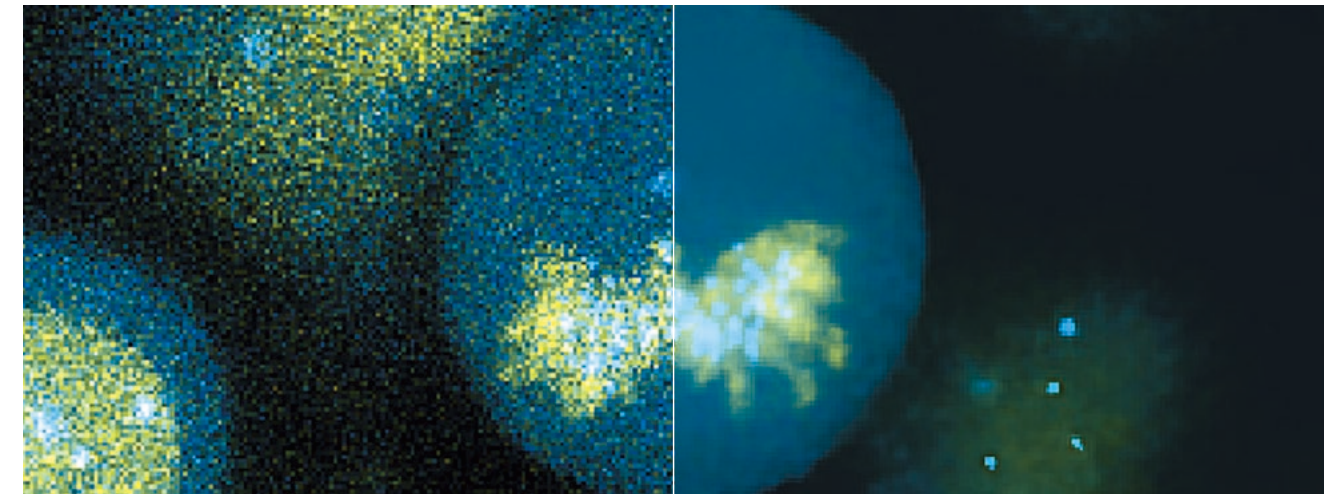

Before denoising

After denoising

Deconvolution

Automatic/manual, robust algorithms are provided to actualize theoretical resolutions. Both 3D and 2D deconvolution are available.

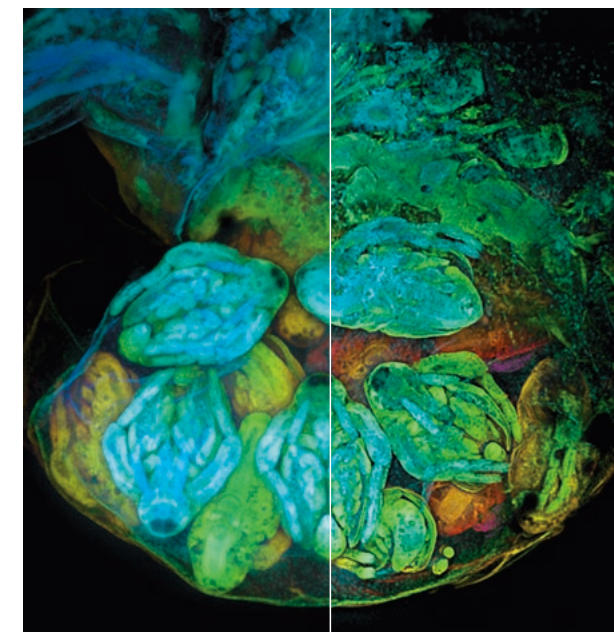

Before deconvolution

After deconvolution

Image analysis

Automatic measurement

Segmentation tools, morphology functions, classifiers, and an extensive list of measurement tools for 2D, 3D and timelapse datasets.

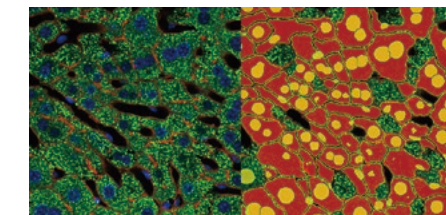

2D and 3D object tracking

Identifying and tracking 2D and 3D objects. Measurements include velocity, acceleration, distance, and direction.

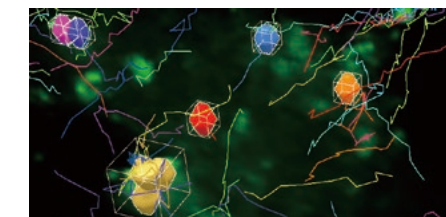

Real-time measurement

Time measurements can be carried out in real time and visualized during acquisition.

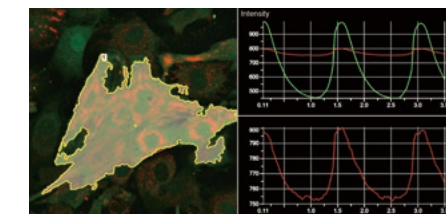

Highest performance optics for confocal imaging

A selection of high numerical aperture (NA) objectives are available, which provide chromatic aberration correction for UV to near-infrared.

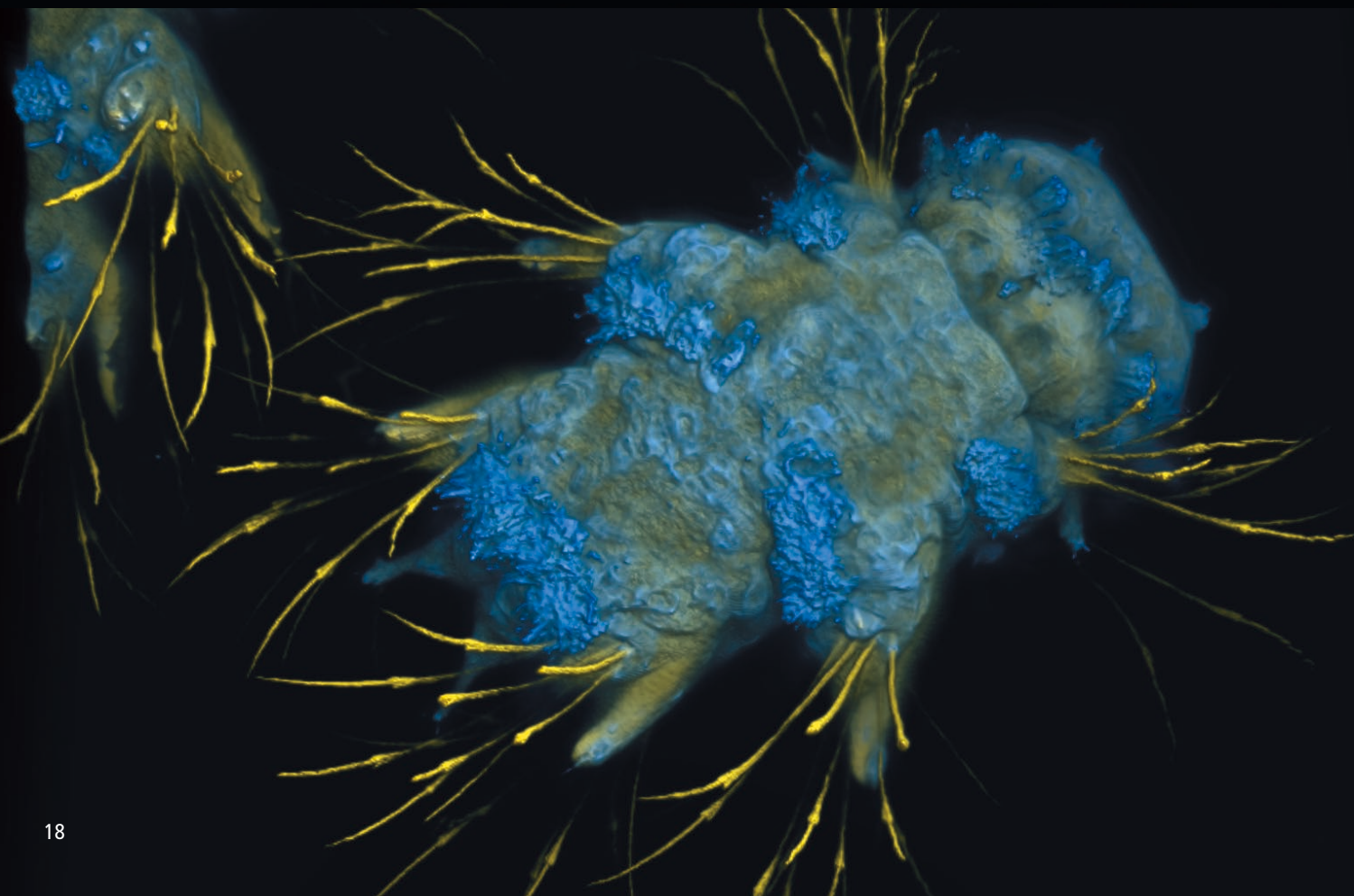
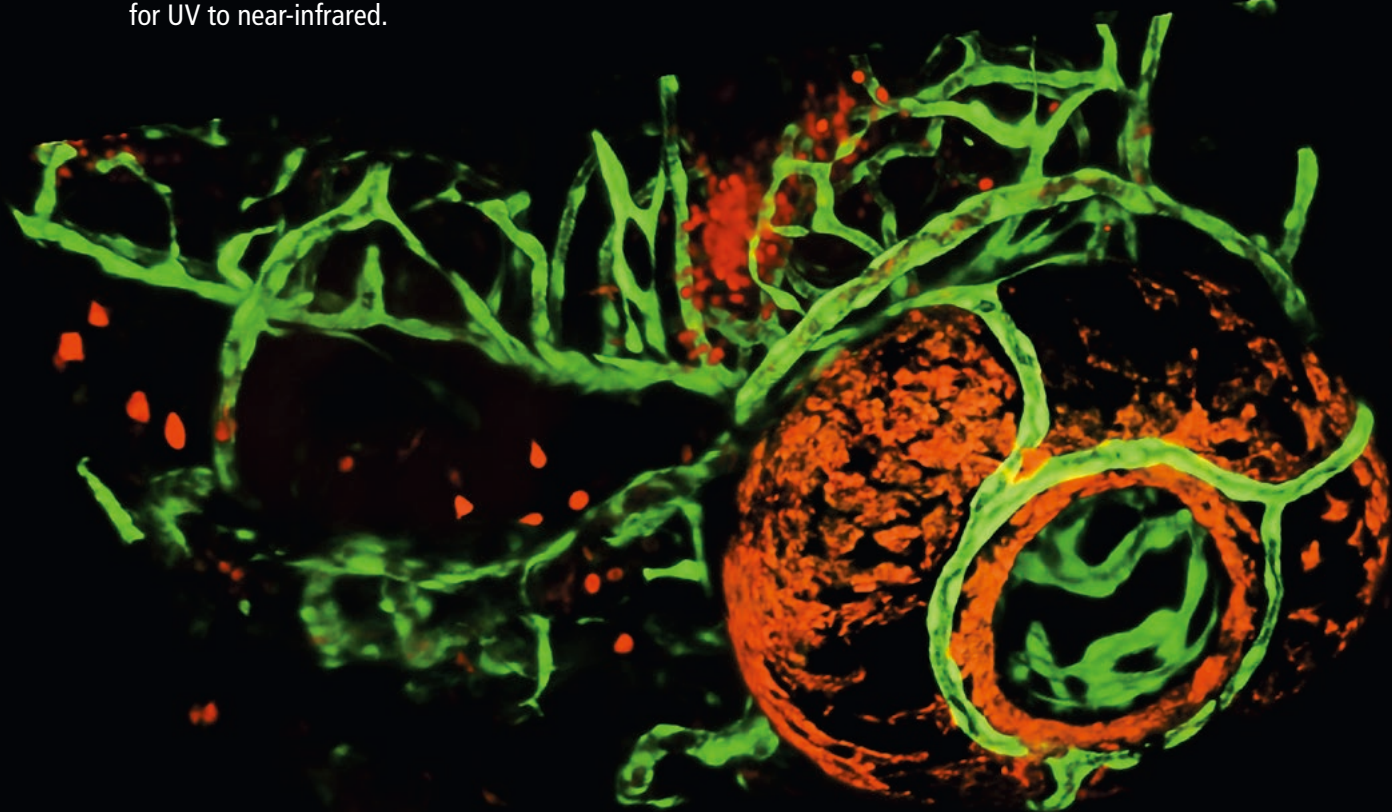

CFI SR HP Plan Apochromat Lambda S 100XC Sil

By using silicone oil that has a refractive index closely matching that of live cells as its immersion liquid, this lens allows high resolution imaging of thick samples and is suitable for long-term time-lapse imaging.

- Numerical aperture: 1.35
- Chromatic aberration correction: from visible to UV
- Nano Crystal Coat applied.



CFI75 Apochromat 25XC W

This lens is suitable for multicolor imaging of living cells.

- Working distance: 2.0 mm
- Numerical aperture: 1.10
- Chromatic aberration correction: from visible to near-IR
- Nano Crystal Coat applied.



CFI Plan Apochromat VC 60XC WI

This lens' chromatic aberration correction up to the UV range enables accurate multicolor confocal imaging

- Chromatic aberration correction: the full visible wavelength range over 405 nm
- Superior image flatness



CFI Apochromat Lambda S 40XC WI

Its high NA for water immersion objectives provides brighter and higher-resolution images and makes this lens ideal for confocal live cell imaging.

- Numerical aperture: 1.25
- Chromatic aberration correction: from UV through to near IR
- Nano Crystal Coat applied.



CFI Apochromat TIRF 60XC Oil

This lens has the industry's highest NA, providing unparalleled resolution and efficient acquisition of fluorescent signals in confocal imaging.

- Numerical aperture: 1.49
- Chromatic aberration correction: from UV through to near IR

Nano Crystal Coat for superior transmission

Nikon's exclusive Nano Crystal Coat is an anti-reflective coating consisting of ultra-fine crystalline particles. This forms a coarse structure that enables lower refractive indices, facilitating the passage of light through the lens rather than reflecting it, thus providing superior light transmission.

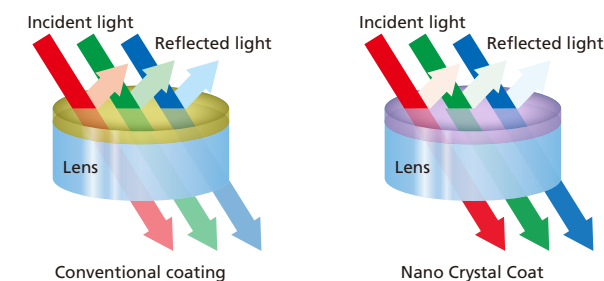

Objectives

CFI SR HP Plan Apochromat Lambda S 100XC Sil	NA 1.35	WD 0.31-0.29 (23°C) WD 0.30-0.28 (37°C)	
CFI Plan Apochromat Lambda 10X	NA 0.45	WD 4.00	
CFI Plan Apochromat Lambda 40XC	NA 0.95	WD 0.25-0.16	
CFI Plan Apochromat VC 20X	NA 0.75	WD 1.00	
CFI Plan Apochromat VC 60XC WI	NA 1.20	WD 0.31-0.28	
CFI Plan Apochromat IR 60XC WI	NA 1.27	WD 0.18-0.16	
CFI Apochromat Lambda S 40XC WI	NA 1.25	WD 0.20-0.16	
CFI Apochromat LWD Lambda S 40XC WI	NA 1.15	WD 0.61-0.59	
CFI Apochromat Lambda S 60X Oil	NA 1.40	WD 0.14	
CFI Apochromat TIRF 60XC Oil	NA 1.49	WD 0.16-0.10 (23°C) WD 0.13-0.07 (37°C)	
CFI Apochromat TIRF 100XC Oil	NA 1.49	WD 0.16-0.10 (23°C) WD 0.15-0.09 (37°C)	
CFI75 Apochromat 25XC W	NA 1.10	WD 2.00	

System diagram

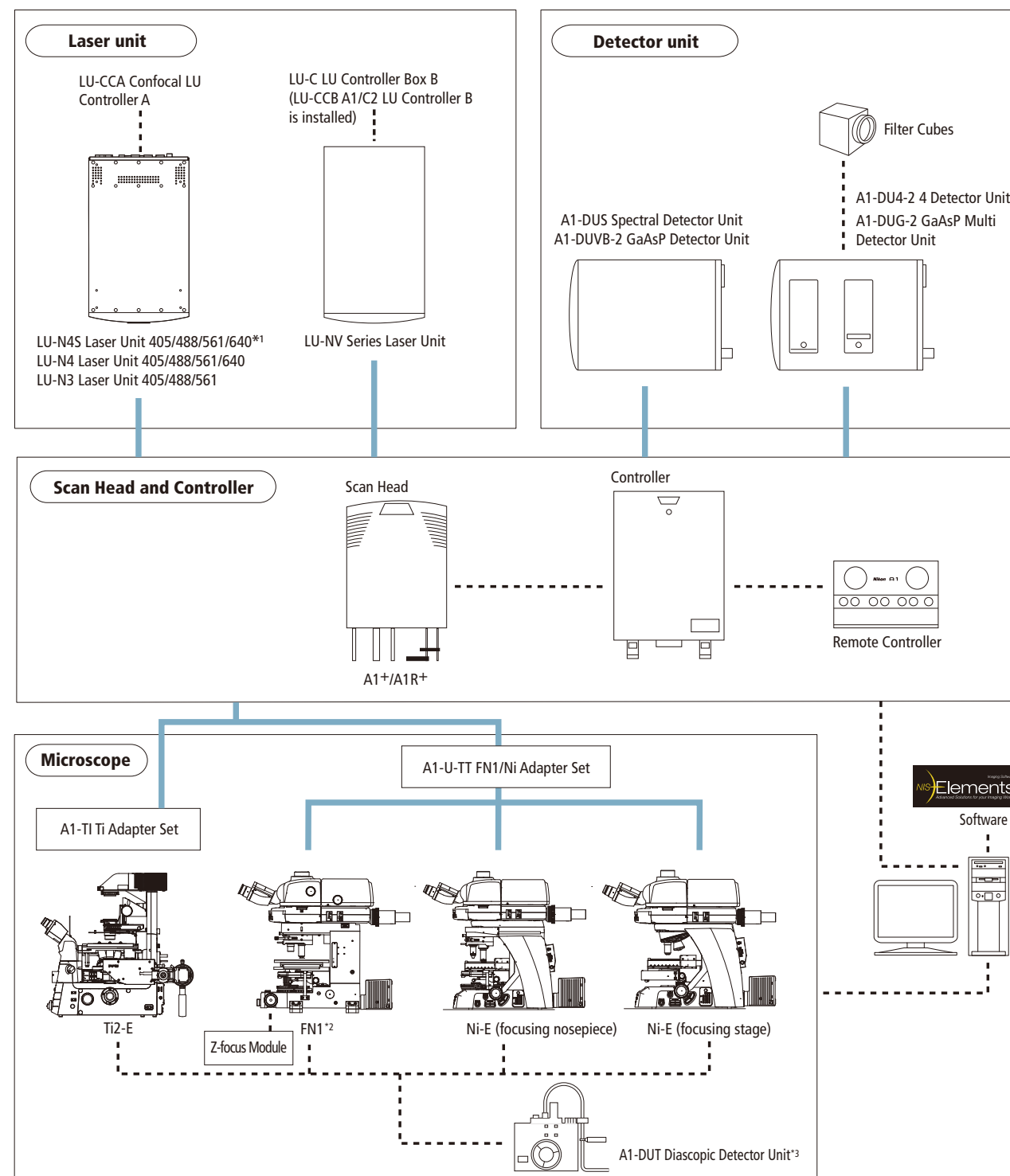

*1 When using Spectral Detector Unit. *2 NI-TT Quadrocular Tilting Tube can be used. *3 Dedicated adapter may be required, depending on microscope model.

Specifications

	A1+	A1R+
Scan head input/output port	2 laser input ports 3 signal output ports for standard, spectral and optional detector*1	
Laser	LU-N3 3-laser unit	405 nm, 488 nm, 561nm lasers are installed; built-in AOTF *Cannot be used with A1-DUS spectral detector
	LU-N4/N4S 4-laser unit	405 nm, 488 nm, 561 nm, 640 nm lasers are installed; built-in AOTF *LU-N4 cannot be used with A1-DUS spectral detector
	LU-NV series laser unit	Compatible lasers : 405 nm, 445 nm, 458 nm, 488 nm, 514 nm, 532 nm, 561 nm, 594 nm, 640 nm, 647 nm ; built-in AOTF
Standard fluorescence detector	Wavelength	400-750 nm
	Detector	A1-DU4-2 4 Detector Unit: 4 Multi-Alkali PMTs A1-DUG-2 GaAsP Multi Detector Unit: 2 GaAsP PMTs + 2 Multi-Alkali PMTs
Diascopic detector (option)	Filter cube	6 filter cubes commonly used for a microscope mountable on each of three filter wheels Recommended wavelengths: 450/50, 482/35, 515/30, 525/50, 540/30, 550/49, 585/65, 595/50, 700/75
	Wavelength	485-650 nm
	Detector	Multi-Alkali PMT
FOV	Square inscribed in a ø18 mm circle	
Image bit depth	4096 gray intensity levels (12 bit)	
Scan head	Standard image acquisition	Scanner: galvano scanner x2 Pixel size: max. 4096 x 4096 pixels Scanning speed: Standard mode: 2 fps (512 x 512 pixels, bi-direction), 24 fps (512 x 32 pixels, bi-direction) Fast mode: 10 fps (512 x 512 pixels, bi-direction), 130 fps (512 x 32 pixels, bi-direction) ² Zoom: 1-1000x continuously variable Scan mode: X-Y, X-T, X-Z, XY rotation, Free line, Line-Z
	High-speed image acquisition	Scanner: resonant scanner (X-axis, resonance frequency 7.8 kHz), galvano scanner (Y-axis) Pixel size: max. 1024 x 1024 pixels Scanning speed: 15 fps (1024 x 1024 pixels), 30 fps (512 x 512 pixels), 60 fps (256 x 256 pixels) to 420 fps (512 x 32 pixels), 15,600 lines/sec (line speed) Zoom: 7 steps (1x, 1.5x, 2x, 3x, 4x, 6x, 8x) Scan mode: X-Y, X-T, X-Z Acquisition method: High-speed image acquisition, Simultaneous photoactivation and image acquisition
Spectral detector (option)	Dichroic mirror	Low-angle incidence method, Number of positions: 8 Standard filter: 405/488, 405/488/561, 405/488/561/638, 405/488/543/638, 457/514, BS20/80 Optional filter: 457/514/561
	Pinhole	12-256 μm variable (1st image plane)
	A1-DUS spectral detector unit	Number of channels: 32 Wavelength detection range: 400 - 750 nm Spectral image acquisition speed: 4 fps (256 x 256 pixels) Maximum pixel size: 2048 x 2048 (Spectral mode/Virtual filter mode) Wavelength resolution: 2.5/6.0/10.0 nm, wavelength range variable in 0.25 nm steps Compatible with galvano scanner only
A1-DUVB-2 GaAsP detector unit	Number of channels: 1 GaAsP PMT with variable emission plus 1 optional GaAsP PMT (A1-DUVB-OP) with a user-defined dichroic mirror and barrier filter Wavelength detection range: 400 - 720 nm, narrowest: 10 nm, broadest: 320 nm Maximum pixel size: 4096 x 4096 (CB mode/VB mode) Wavelength resolution: 10 nm, wavelength range variable in 1 nm steps Compatible with galvano and resonant scanners	
Z step	Ti2-E: 0.02 μm, FN1 stepping motor: 0.05 μm, Ni-E: 0.025 μm	
Compatible microscopes	ECLIPSE Ti2-E inverted microscope, ECLIPSE FN1 fixed stage microscope, ECLIPSE Ni-E upright microscope (focusing nosepiece type and focusing stage type)	
Option	Motorized XY stage (for Ti2-E/Ni-E), High-speed Z stage (for Ti2-E), High-speed piezo objective-positioning system (for FN1/Ni-E)	
Software	Display/image generation	2D analysis, 3D volume rendering/orthogonal, 4D analysis, spectral unmixing
	Image format	JP2, JPG, TIFF, BMP, GIF, PNG, ND2, JFF, JTF, AVI, ICS/IDS
	Application	FRAP, FLIP, FRET(option), photoactivation, three-dimensional time-lapse imaging, multipoint time-lapse imaging, colocalization
Control computer	OS	Windows 10 Pro 64bit, English version or Japanese version OS Version 1704 Windows 7 Professional, 64bit, SP1 English version or Japanese version, Windows Update KB3118401 or later
	CPU	Intel Xeon E5-2643v4 (3.40GHz, 6 cores, 20MB, 2400MHz) or higher
	RAM	16GB, 32GB or 64GB
	HDD	1st HP Z Turbo G2 512GB PCIe M.2 SSD 2nd SATA 2TB
	Optical Drive	Super Multi drive, up to x 16 speed or higher
	Graphics	NVIDIA Quadro K620/ K2200/ K4200/ M2000/ M4000/ M5000 (PCI Express / two-screen split display supported)
	Extension slot	Two PCI Express 3.0 (x16) slots (one slot to be used for graphics) One PCI Express 3.0 (x8 mechanical, x4 electrical) slot One PCI Express 2.0 (x8 mechanical, x4 electrical) slot One PCI Express 2.0 (x1) slot
LAN port	10/100/1000 Network/Interface x 2 (for connection to controller, for connection to external LAN)	
Monitor	1600 x 1200 or higher resolution, dual monitor configuration recommended	
Recommended installation conditions	Temperature 23 ± 5 °C, humidity 70 % (RH) or less (non-condensing)	

*1 FCS/FCFS/FLIM is possible in combination with third-party systems

*2 Fast mode is compatible with zoom 8-1000x and scanning modes X-Y and X-T. It is not compatible with Rotation, Free line, CROP, ROI, Spectral imaging, Stimulation and FLIM.

Laser units with great flexibility and efficiency

LU-NV series

- Supports up to eight wavelengths and switching between seven fiber outputs.
- Lasers available for this series are: 405 nm, 445 nm, 458 nm, 488 nm, 514 nm, 532 nm, 561 nm, 594 nm, 640 nm and 647 nm.
- High-power lasers for the N-SIM/N-STORM super resolution microscope are available.



LU-N4/N4S 4-laser unit/ LU-N3 3-laser unit

The LU-N4/LU-N4S is equipped with four lasers (405 nm, 488 nm, 561 nm, and 640 nm), while the LU-N3 has three lasers (405 nm, 488 nm, and 561 nm). The LU-N4S is compatible with spectral imaging.



Layout

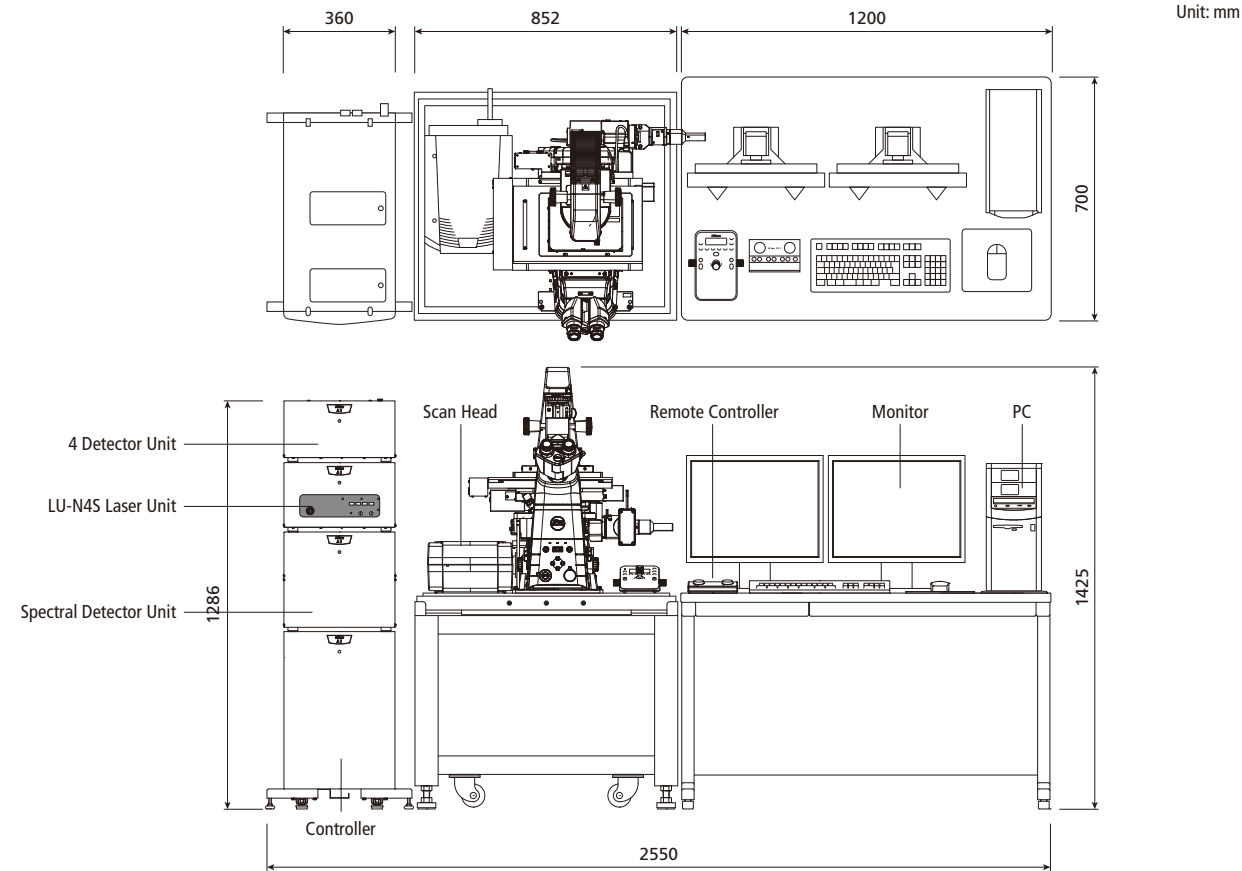

Unit: mm

* Layout sample

Dimensions and weight

Scan Head	276(W) x 163(H) x 364(D) mm	Approx. 10 kg
Controller	360(W) x 580(H) x 600(D) mm	Approx. 40 kg
A1-DU4-2 4 Detector Unit	360(W) x 199(H) x 593.5(D) mm	Approx. 16 kg
A1-DUG-2 GaAsP Multi Detector Unit	360(W) x 199(H) x 593.5(D) mm	Approx. 16 kg
A1-DUS Spectral Detector Unit	360(W) x 323(H) x 593.5(D) mm	Approx. 26 kg
A1-DUVB-2 GaAsP Detector Unit	360(W) x 114(H) x 595.5(D) mm	Approx. 10 kg
LU-N4/N4S/N3 Laser Unit	360(W) x 210(H) x 593.5(D) mm	Approx. 16 kg
LU-NV Laser Unit	400(W) x 781(H) x 685(D) mm	Approx. 70 kg
LU Controller Box B (for LU-NV)	400(W) x 123(H) x 687(D) mm	Approx. 7 kg

Power source

A1+/A1R+ System	Scan Head and Controller	Input 100-240V ± 10%, 50-60Hz, 5A-2A
	Computer Unit	Input 100-240V ± 10%, 50-60Hz, 12A-10A
Laser Unit	LU-N4/LU-N4S/LU-N3	Input 100-240V ± 10%, 50-60Hz, 2A max.
	LU-NV Series	Input 100-240V ± 10%, 50-60Hz, 4.8A max.
	LU Controller Box B (for LU-NV)	Input 100-240V ± 10%, 50-60Hz, 1A max.
Microscope	Inverted Microscope Ti2-E and HG Fiber Illuminator Intensilight	Input 100-240V ± 10%, 50-60Hz, 6.3A max.

Note: When an air compressor is used with a vibration isolated table, an additional power source is necessary.

Diverse peripherals and systems for pursuit of live cell imaging

A1+ with N-SIM, A1+ with N-STORM and A1+ with TIRF

A1+/A1R+ can be equipped with the TIRF system and super resolution microscope systems N-SIM, N-STORM on a single inverted microscope and all controlled from Nikon's integrated software. This meets the demands of multi-perspective cellular analysis. N-SIM provides super resolution of approximately double that of conventional microscopes, while N-STORM provides approximately 10 times higher super resolution. TIRF enables visualization of ultra-thin optical specimen sections of approximately 100 nm, enabling the observation of single molecules.

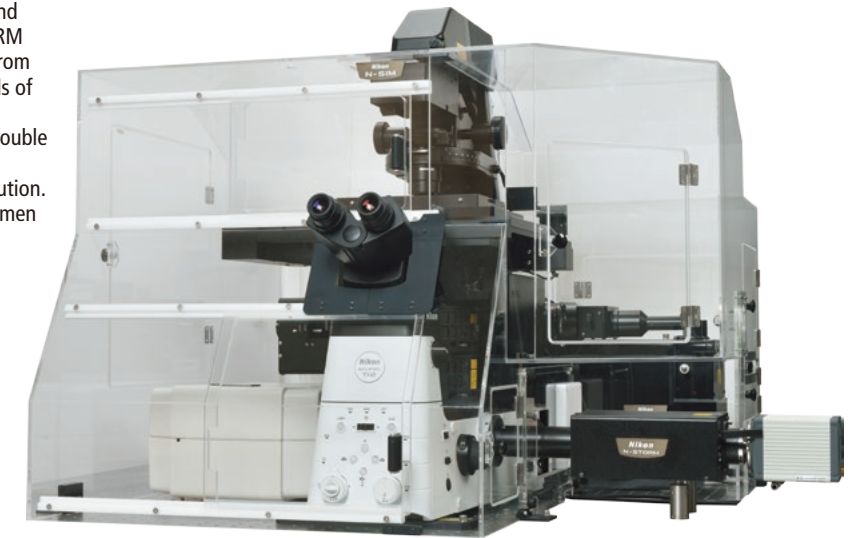

Configured with N-SIM, N-STORM and confocal microscope A1+

Confocal microscope with Perfect Focus System

With the inverted microscopes Ti2-E, an automatic focus maintenance mechanism—Perfect Focus System (PFS) can be used. It continuously corrects focus drift during long time-lapse observation and when reagents are added.

*Use with glass bottom dish is recommended.

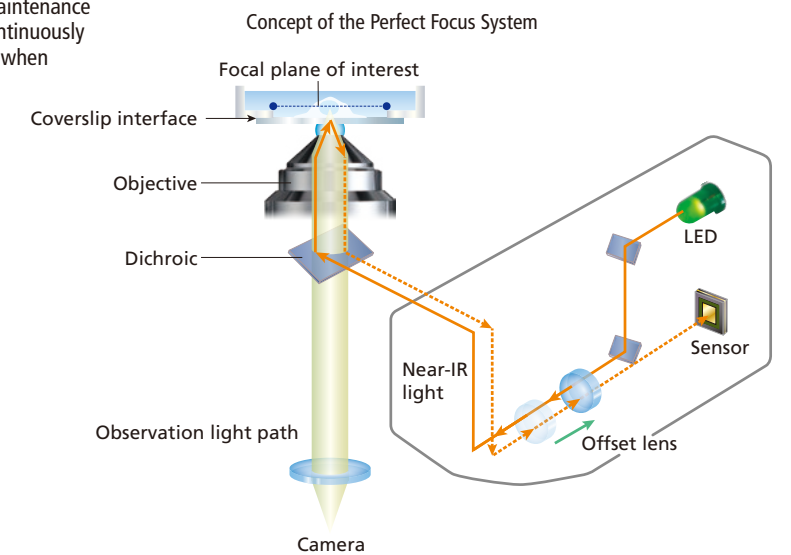

Water Immersion Dispenser

The Water Immersion Dispenser increases the stability of long-term imaging using PFS, by automatically applying the appropriate amount of water to the tip of a water immersion objective, preventing the immersion liquid from drying out or overflowing during experiments.



Specifications and equipment are subject to change without any notice or obligation on the part of the manufacturer. August 2017 ©2010-17 NIKON CORPORATION

 WARNING	TO ENSURE CORRECT USAGE, READ THE CORRESPONDING MANUALS CAREFULLY BEFORE USING YOUR EQUIPMENT.
--	---

Monitor images are simulated.

Company names and product names appearing in this brochure are their registered trademarks or trademarks. N.B. Export of the products* in this brochure is controlled under the Japanese Foreign Exchange and Foreign Trade Law. Appropriate export procedure shall be required in case of export from Japan.

*Products: Hardware and its technical information (including software)

WARNING-LASER RADIATION AVOID EXPOSURE TO BEAM CLASS 3B LASER PRODUCT Total Power 500mW MAX. CW 400~700nm IEC/EN60825-1 : 2007, 2014
Complies with FDA performance standards for laser products except for deviations pursuant to Laser Notice No. 50, dated June 24, 2007.

DANGER-VISIBLE AND INVISIBLE LASER RADIATION AVOID EYE OR SKIN EXPOSURE TO DIRECT OR SCATTERED RADIATION CLASS 4 LASER PRODUCT Total Power 1500mW MAX. CW 370~790nm IEC/EN60825-1 : 2007, 2014
Complies with FDA performance standards for laser products except for deviations pursuant to Laser Notice No.50 dated June 24, 2007.



NIKON CORPORATION

Shinagawa Intercity Tower C, 2-15-3, Konan, Minato-ku, Tokyo 108-6290, Japan
phone: +81-3-6433-3705 fax: +81-3-6433-3785
<http://www.nikon.com/products/microscope-solutions/>

ISO 14001 Certified
for NIKON CORPORATION

NIKON INSTRUMENTS INC.

1300 Walt Whitman Road, Melville, N.Y. 11747-3064, U.S.A.
phone: +1-631-547-8500; +1-800-52-NIKON (within the U.S.A. only)
fax: +1-631-547-0306
<http://www.nikoninstruments.com/>

NIKON INSTRUMENTS EUROPE B.V.

Tripolis 100, Burgenweeshuispad 101, 1076 ER Amsterdam, The Netherlands
phone: +31-20-7099-0000 fax: +31-20-7099-298
<http://www.nikoninstruments.eu/>

NIKON INSTRUMENTS (SHANGHAI) CO., LTD.

CHINA phone: +86-21-6841-2050 fax: +86-21-6841-2060
(Beijing branch) phone: +86-10-5831-2028 fax: +86-10-5831-2026
(Guangzhou branch) phone: +86-20-3882-0550 fax: +86-20-3882-0580

NIKON CANADA INC.

CANADA phone: +1-905-602-9676 fax: +1-905-602-9953

NIKON FRANCE S.A.S.

FRANCE phone: +33-1-4516-45-16 fax: +33-1-4516-45-55

NIKON GMBH

GERMANY phone: +49-211-941-42-20 fax: +49-211-941-43-22

NIKON INSTRUMENTS S.p.A.

ITALY phone: +39-55-300-96-01 fax: +39-55-30-09-93

NIKON GMBH SWITZERLAND

SWITZERLAND phone: +41-43-277-28-67 fax: +41-43-277-28-61

NIKON UK LTD.

UNITED KINGDOM phone: +44-208-247-1717 fax: +44-208-541-4584

NIKON CEE GMBH

AUSTRIA phone: +43-1-972-6111 fax: +43-1-972-611-140

NIKON SINGAPORE PTE LTD

SINGAPORE phone: +65-6559-3651 fax: +65-6559-3668

NIKON INSTRUMENTS KOREA CO., LTD.

KOREA phone: +82-2-2186-8400 fax: +82-2-555-4415